



Model #	
Type	
Project	
Date	

WP7-SERIES TRADITIONAL WALL PACK

The WP7-Series LED Traditional Style Wall Pack uses industry-leading LED chips and drivers to deliver a quality, energy saving lighting solution. It is also designed for an easy install, directly fitting onto existing electrical boxes, making it the contractor's choice when replacing older high pressure sodium and metal halide wall packs.



HIGHLIGHTS

- Up to 150 lm/W
- 80+ CRI
- Aluminum alloy housing for corrosion resistance
- Traditional style wall pack using modern, energy efficient LED technology
- -40°F / -40°C minimum starting temperature
- IP65 rated
- Uses a glass lens that won't haze over time and provides high light transmission and clarity
- Backed by a worry-free 10 year warranty
- Optional accessories: Glare Shield to reduce uplight/ side glare and Wire Guard for additional protection.

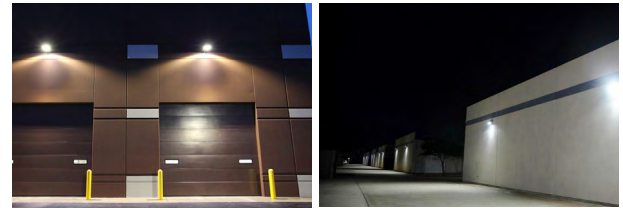

APPLICATIONS

Designed for outdoor applications in commercial, industrial, institutional, and retail spaces.

DIMENSIONS					
VOLTAGE (V)	WATTAGE (W)	L (inches/mm)	W (inches/mm)	H (inches/mm)	WEIGHT (kg/lbs)
120-277V	29	14-7/16" (366mm)	9-5/16" (236mm)	7-3/8" (188mm)	3.5kg / 7.7lbs
	50				3.8kg / 8.1lbs
	80				3.8kg / 8.4lbs
	120				3.9kg / 8.6lbs
120-347V	29	14-7/16" (366mm)	9-5/16" (236mm)	7-3/8" (188mm)	3.2kg / 7.7lbs
	50				3.8kg / 8.1lbs
	80				3.8kg / 8.4lbs
	120				3.9kg / 8.6lbs

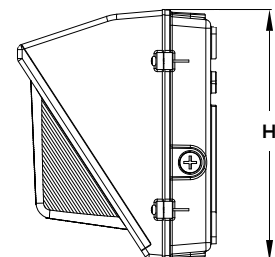
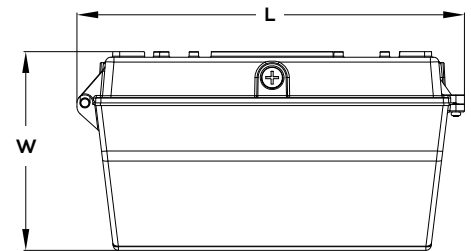

ORDERING GUIDE

SERIES	-	POWER (W)	-	CCT	-	VOLTAGE
WP7	-	30: 29W 50: 50W 80: 80W 120: 120W	-	4: 4000K 5: 5000K	-	1: 120-277V 3: 120-347V

MODEL SELECTION

SERIES	-	POWER (W)	-	CCT	-	VOLTAGE
WP7	-	30	-	4	-	1

ACCESSORIES SELECTION

EXAMPLE: WP7-304-1

ORDER	MODEL #	DESCRIPTION
	WP7-SHIELD	Glare Shield (all models)
	WP7-WG	Wire Guard (all models)
	ST347	347V Photocell, 1/2" Knockout plug (all models)

*Shield and wire guard are compatible together.

PRODUCT FEATURES

CONSTRUCTION

- Die-cast Aluminum
- Five (5) 1/2" NPT knockouts
- One (1) 3/4" NPT knockout
- Glass lens
- Bronze housing color

INSTALLATION

- Junction box wall mount; no junction box wall mount; 1ft dimming wires; knockouts = 6, 5 x 1/2" NPT, 1 x 3/4" NPT

ELECTRICAL

- "-1" models designed to operate between 120-277V
- "-3" models designed to operate between 120-347V
- LED drivers have up to 6kV inherent surge protection
- Power Factor >0.9
- THD <20%
- 0-10V dimming
- 120-277V models include an integrated photocell sensor
- For 120-347V models, an optional 347V external photocell is available separately

LISTINGS & RATINGS

- cULus
- Wet Location
- IP65
- Listed for use in -40°C to 50°C / -40°F to 122°F

RATED LIFE & WARRANTY



- LED system: >50,000 hours at L70
- 10 year warranty (visit premiseled.com/warranty/)

ORDERING INFORMATION

INPUT VOLTAGE	POWER (W)	CCT (K)	MODEL NUMBER	DELIVERED LUMENS (LM)	EFFICACY (lm/W)	DLC PREMIUM
120-277V	29W	4K	WP7-304-1	4,097 lm	146 lm/W	P401DWYF
	50W	4K	WP7-504-1	7,261 lm	146 lm/W	PJ802SCT
	80W	4K	WP7-804-1	12,161 lm	148 lm/W	P1D4SB64
	120W	4K	WP7-1204-1	17,446 lm	141 lm/W	P5VXUXRD
	29W	5K	WP7-305-1	4,118 lm	147 lm/W	PE1P7TSM
	50W	5K	WP7-505-1	7,289 lm	148 lm/W	PY4FYWLZ
	80W	5K	WP7-805-1	12,237 lm	149 lm/W	PBEMPF2V
	120W	5K	WP7-1205-1	17,496 lm	142 lm/W	PI0AI7ZY
120-347V	29W	4K	WP7-304-3	4,163 lm	148 lm/W	PTDPAGNE
	50W	4K	WP7-504-3	7,352 lm	148 lm/W	PXQBNXBG
	80W	4K	WP7-804-3	11,322 lm	142 lm/W	PAAZD350
	120W	4K	WP7-1204-3	17,224 lm	142 lm/W	PPQ40BAX
	29W	5K	WP7-305-3	4,178 lm	150 lm/W	PO8UW6QI
	50W	5K	WP7-505-3	7,452 lm	149 lm/W	PGAOW7P8
	80W	5K	WP7-805-3	11,396 lm	144 lm/W	PC8S0C92
	120W	5K	WP7-1205-3	17,338 lm	143 lm/W	P7XDM6WO

OPTIONAL ACCESSORIES

OTHER ACCESSORIES

IMAGE	DESCRIPTION	MODEL NUMBER
	Glare Shield for Traditional Wall Packs	WP7-SHIELD (all models)
	Wire Guard for Traditional Wall Packs	WP7-WG (all models)
	347V Photocell, 1/2" Knockout plug	ST347 (all 347V models)

PACKING INFORMATION

MODEL	CASE QUANTITY	PALLET QUANTITY
29W	CASE OF 1	54
50W	CASE OF 1	54
80W	CASE OF 1	54
120W	CASE OF 1	54

ELECTRICAL INFORMATION

INPUT VOLTAGE	POWER (W)	APPARENT POWER (VA)	SYSTEM WATTAGE (W)	CURRENT DRAW AT 120V _{ac}	CURRENT DRAW AT 208V _{ac}	CURRENT DRAW AT 240V _{ac}	CURRENT DRAW AT 277V _{ac}	CURRENT DRAW AT 347V _{ac}
120-277V	29W	30.8VA	28.0W	0.245A	0.142A	0.125A	0.111A	-
	50W	53.8VA	49.4W	0.416A	0.245A	0.217A	0.194A	-
	80W	87.6VA	82.0W	0.668A	0.397A	0.352A	0.316A	-
	120W	127.5VA	123.5W	1.001A	0.588A	0.518A	0.460A	-
120-347V	29W	28.2VA	28.0W	0.235A	0.137A	0.120A	0.105A	0.088A
	50W	50.0VA	49.7W	0.416A	0.240A	0.208A	0.183A	0.152A
	80W	79.8VA	79.4W	0.665A	0.383A	0.335A	0.249A	0.241A
	120W	117.9VA	120.9W	0.983A	0.584A	0.509A	0.446A	0.371A

INPUT VOLTAGE	WATTAGE (W)	INRUSH CURRENT (A)	SURGE PROTECTION
120-277V	29W	<50A	L-N: 2.5KV L/N-PE: 2.5KV L-N: 4KV L/N-PE: 4KV L-N: 4KV L/N-PE: 6KV L-N: 6KV L/N-PE: 6KV
	50W	<50A	
	80W	<80A	
	120W	<80A	
120-347V	29W	<60A	L-N: 2KV L/N-PE: 4KV L-N: 2KV L/N-PE: 4KV L-N: 6KV L/N-PE: 6KV L-N: 4KV L/N-PE: 6KV
	50W	<80A	
	80W	<60A	
	120W	<80A	

PHOTOMETRIC INFORMATION

POLAR CANDELA DISTRIBUTION

ILLUMINANCE AT A DISTANCE

WATTAGE
29W

VOLTAGE
100-277V

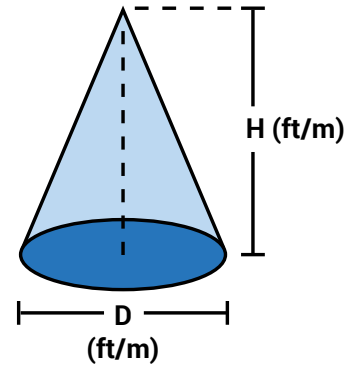
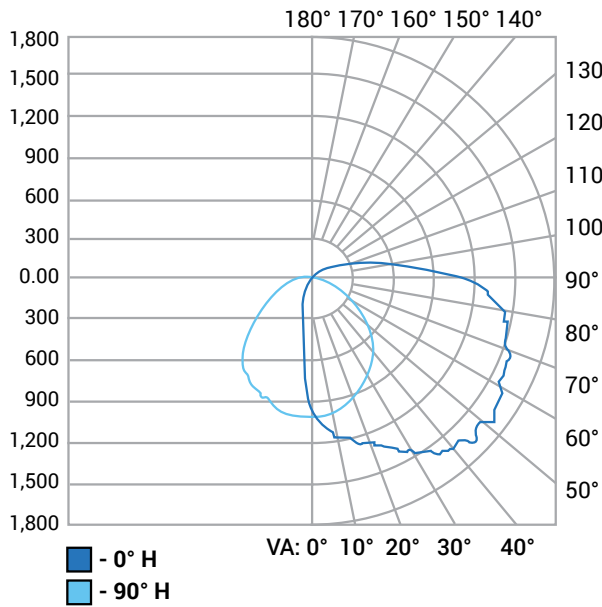

H (ft/m)	LUX	FC	D (ft/m)
6.6' (2m)	258.6	24.0	16.4' (5m)
9.8' (3m)	114.9	10.7	24.6' (7.5m)
13.1' (4m)	64.6	6.0	32.9' (10.0m)
16.4' (5m)	41.4	3.9	40.7' (12.4m)
19.7' (6m)	28.7	2.7	48.9' (14.9m)

POLAR CANDELA DISTRIBUTION

ILLUMINANCE AT A DISTANCE

WATTAGE
50W

VOLTAGE
100-277V

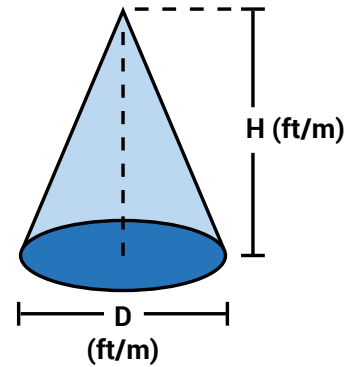
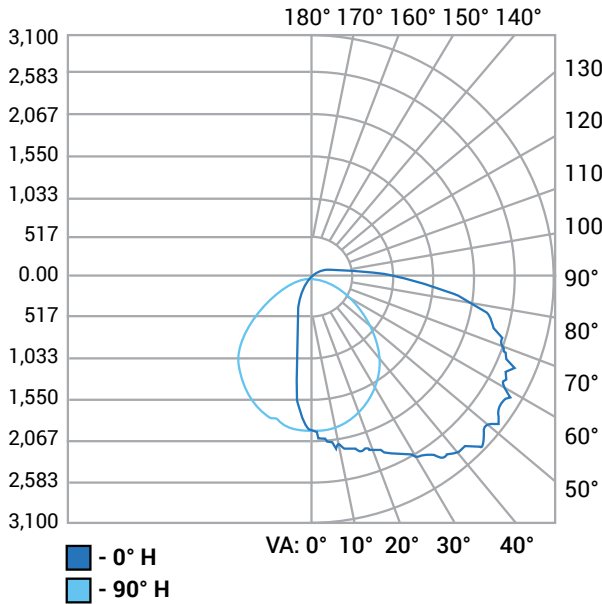

H (ft/m)	LUX	FC	D (ft/m)
6.6' (2m)	480.1	44.6	15.8' (4.8m)
9.8' (3m)	213.4	19.8	23.7' (7.2m)
13.1' (4m)	120.0	11.2	31.5' (9.6m)
16.4' (5m)	76.8	7.1	39.7' (12.1m)
19.7' (6m)	53.3	5.0	47.6' (14.5m)

*Based on operation at 4000K & 277V.

PHOTOMETRIC INFORMATION

POLAR CANDELA DISTRIBUTION

ILLUMINANCE AT A DISTANCE

WATTAGE
80W

VOLTAGE
100-277V

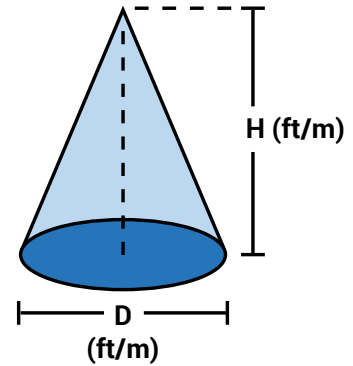
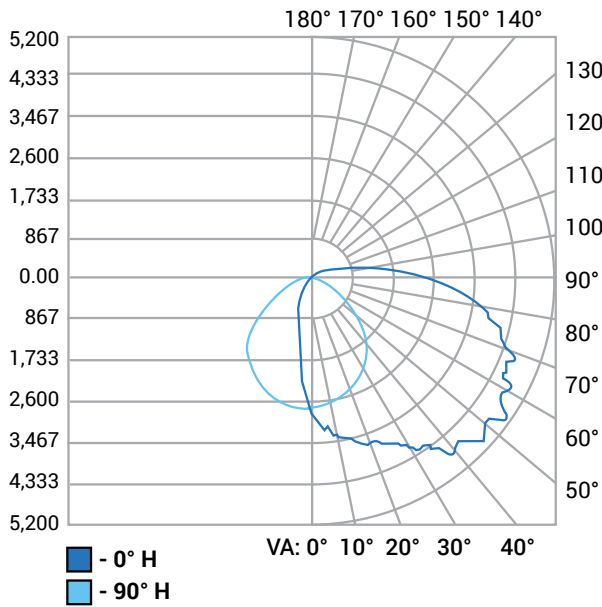

H (ft/m)	LUX	FC	D (ft/m)
6.6' (2m)	688.1	63.9	16.1' (4.9m)
9.8' (3m)	305.8	28.4	24.0' (7.3m)
13.1' (4m)	172.0	16.0	32.2' (9.8m)
16.4' (5m)	110.1	10.2	40.1' (12.2m)
19.7' (6m)	76.5	7.1	48.3' (14.7m)

POLAR CANDELA DISTRIBUTION

ILLUMINANCE AT A DISTANCE

WATTAGE
120W

VOLTAGE
100-277V

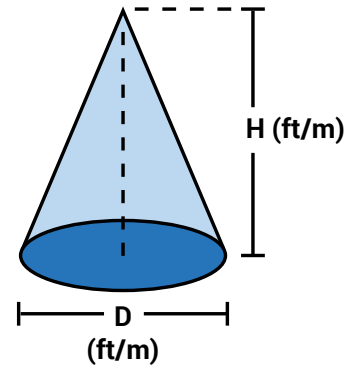
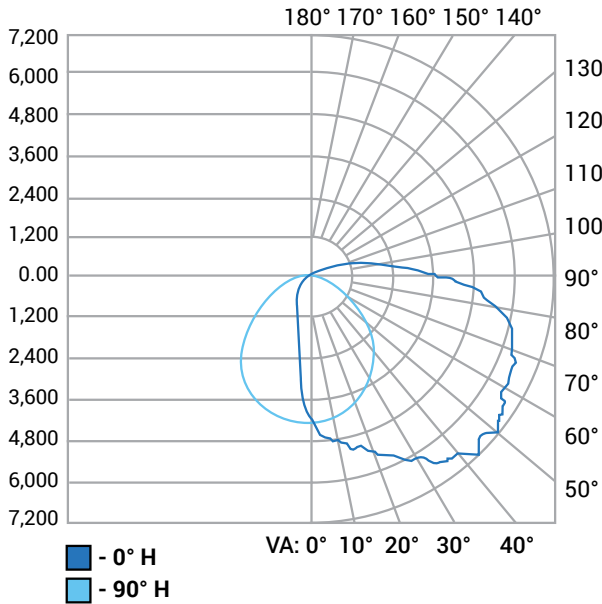

H (ft/m)	LUX	FC	D (ft/m)
6.6' (2m)	1,067.7	99.2	16.1' (4.9m)
9.8' (3m)	474.5	44.1	24.3' (7.4m)
13.1' (4m)	266.9	24.8	32.5' (9.9m)
16.4' (5m)	170.8	15.9	40.4' (12.3m)
19.7' (6m)	118.6	11.0	48.6' (14.8m)

*Based on operation at 4000K & 277V.

PHOTOMETRIC INFORMATION

POLAR CANDELA DISTRIBUTION

ILLUMINANCE AT A DISTANCE

WATTAGE
29W

VOLTAGE
100-347V

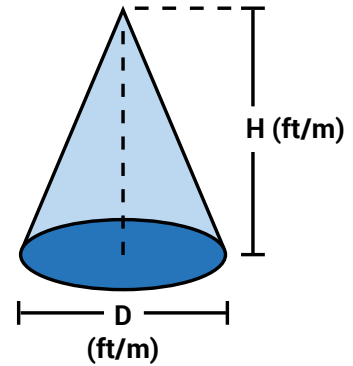
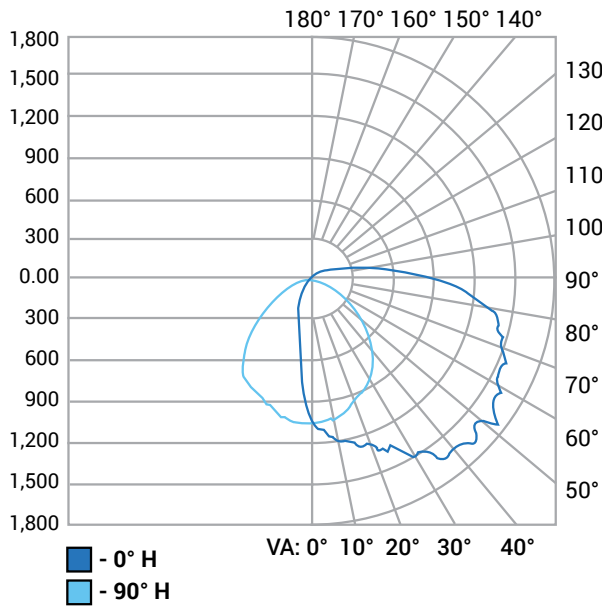

H (ft/m)	LUX	FC	D (ft/m)
6.6' (2m)	258.6	24.0	16.4' (5.0m)
9.8' (3m)	114.9	10.7	24.6' (7.5m)
13.1' (4m)	64.7	6.0	32.9' (10.0m)
16.4' (5m)	41.4	3.9	40.7' (12.4m)
19.7' (6m)	28.7	2.7	48.9' (14.9m)

POLAR CANDELA DISTRIBUTION

ILLUMINANCE AT A DISTANCE

WATTAGE
50W

VOLTAGE
100-347V

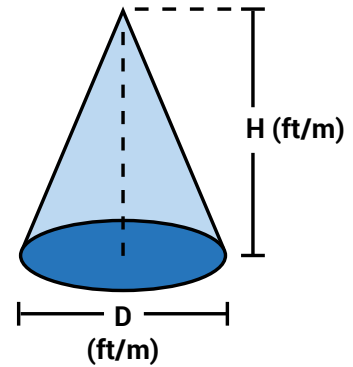
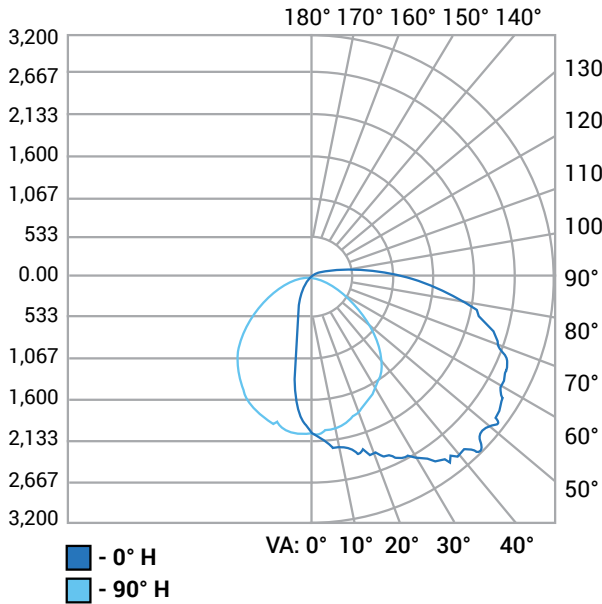

H (ft/m)	LUX	FC	D (ft/m)
6.6' (2m)	511.4	47.5	15.8' (4.8m)
9.8' (3m)	227.3	21.1	24.0' (7.3m)
13.1' (4m)	127.8	11.9	31.9' (9.7m)
16.4' (5m)	81.8	7.6	39.7' (12.1m)
19.7' (6m)	56.8	5.3	47.6' (14.5m)

*Based on operation at 4000K & 347V.

PHOTOMETRIC INFORMATION

POLAR CANDELA DISTRIBUTION

ILLUMINANCE AT A DISTANCE

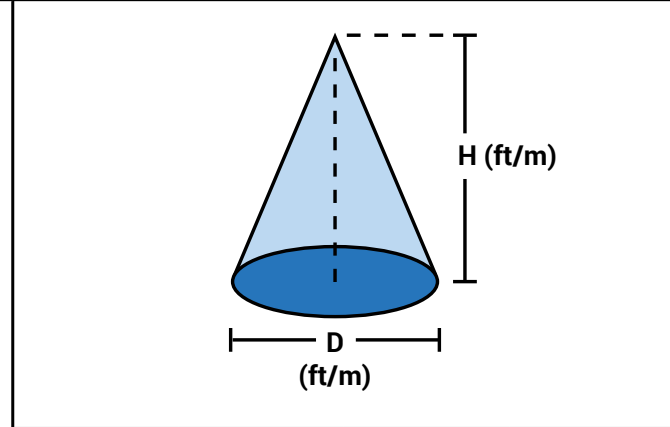
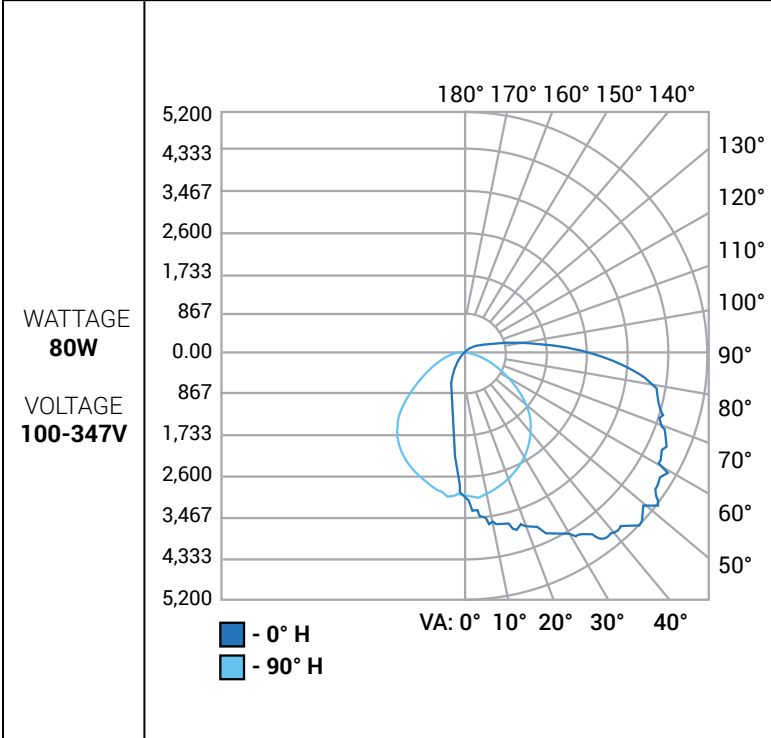

H (ft/m)	LUX	FC	D (ft/m)
6.6' (2m)	690.1	64.1	16.4' (5.0m)
9.8' (3m)	306.7	28.5	24.6' (7.5m)
13.1' (4m)	172.5	16.0	32.9' (10.0m)
16.4' (5m)	110.4	10.3	40.1' (12.5m)
19.7' (6m)	76.7	7.1	49.3' (15.0m)

POLAR CANDELA DISTRIBUTION

ILLUMINANCE AT A DISTANCE

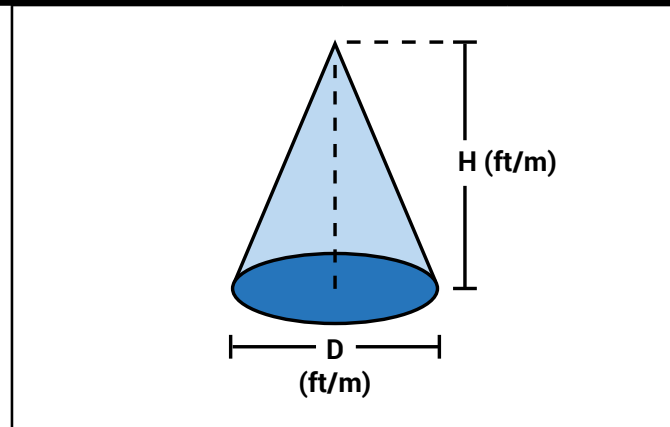
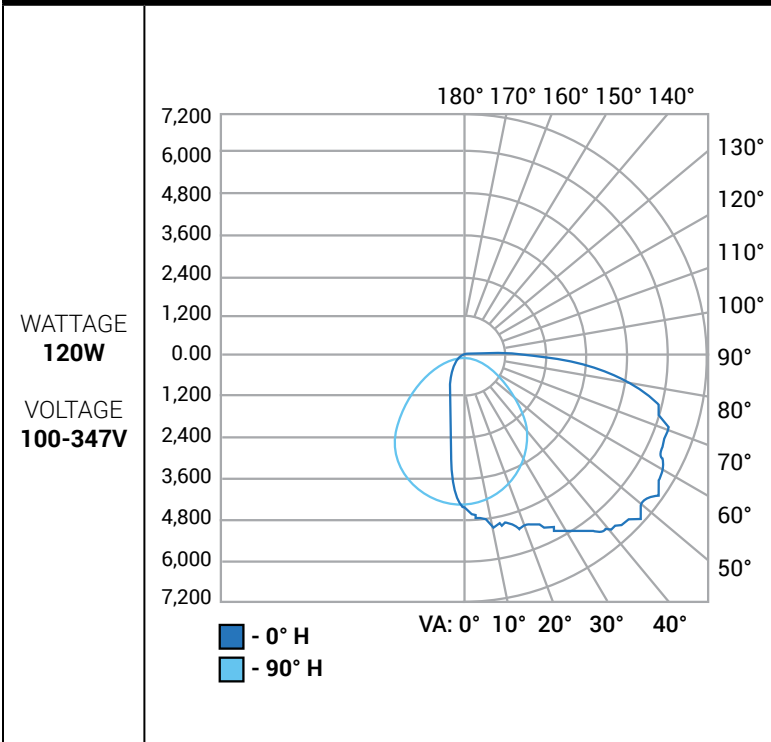

H (ft/m)	LUX	FC	D (ft/m)
6.6' (2m)	1,068.0	99.2	14.1' (4.3m)
9.8' (3m)	474.7	44.1	21.3' (6.5m)
13.1' (4m)	270.0	25.1	28.3' (8.6m)
16.4' (5m)	170.9	15.9	35.5' (10.8m)
19.7' (6m)	118.7	11.0	42.7' (13.0m)

*Based on operation at 4000K & 347V.